

THE NEW VALUE FRONTIER

京瓷 创造新价值



高压内冷对应
切断用刀杆

自动车床用
KGD-JCT

高压内冷对应切断用刀杆

自动车床用 KGD-JCT

NEW

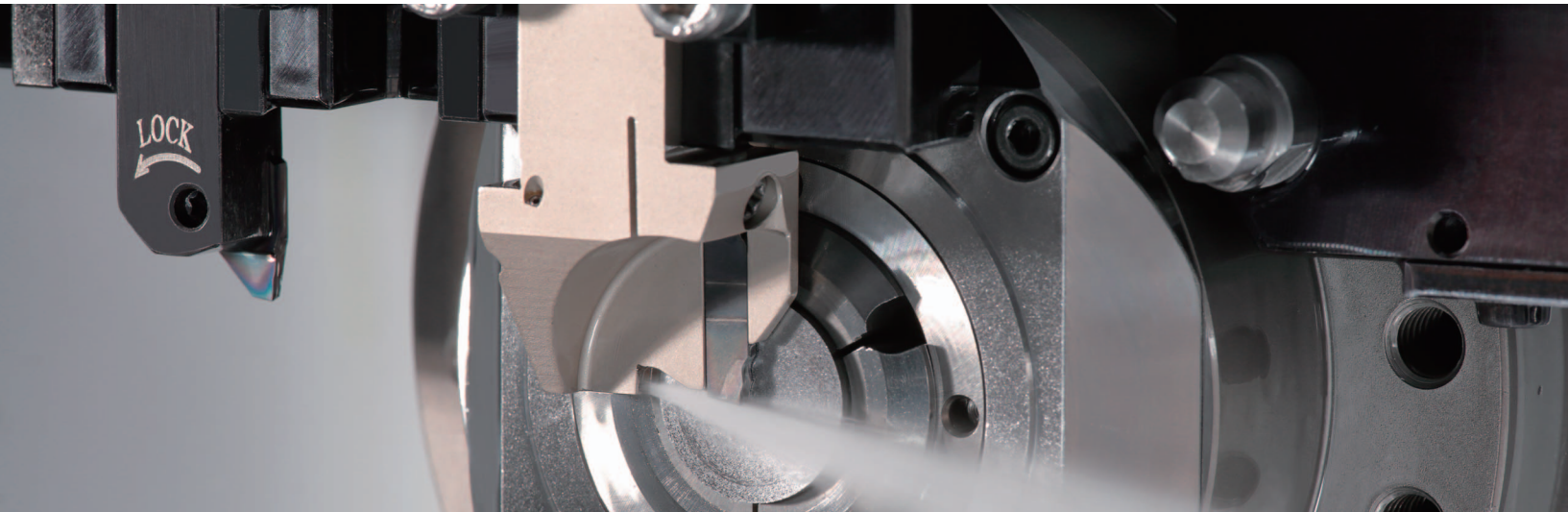

通过内冷效果实现长寿切断加工

自动车床用JCT系列
切断用刀杆 KGD-JCT产品阵容扩大
延长刀具寿命、降低生产成本

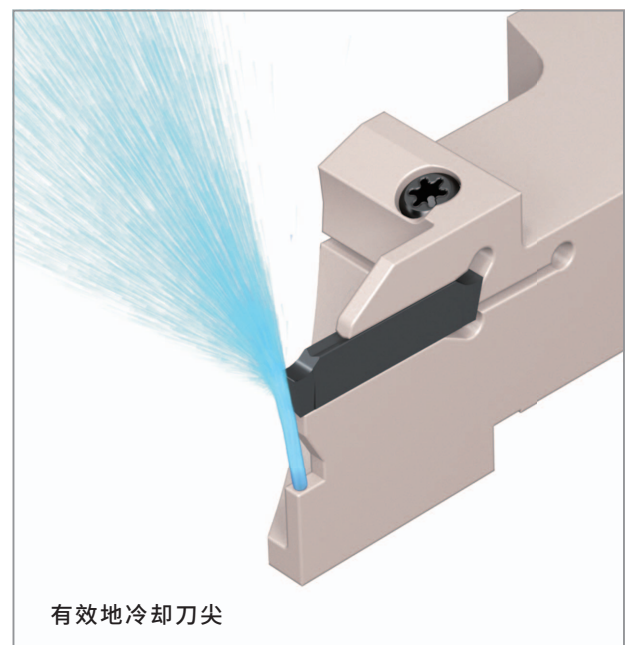
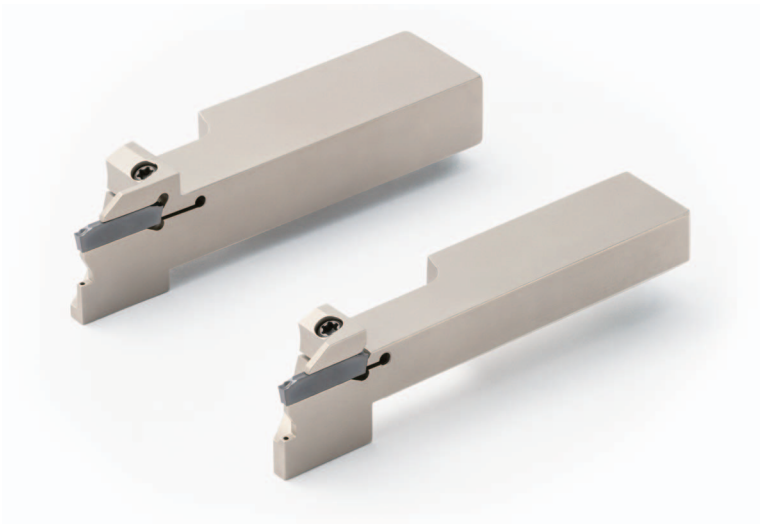

1 优化的内冷孔位置

2 直接向刀片后刀面喷射冷却液

耐磨损性对比 (本公司对比)

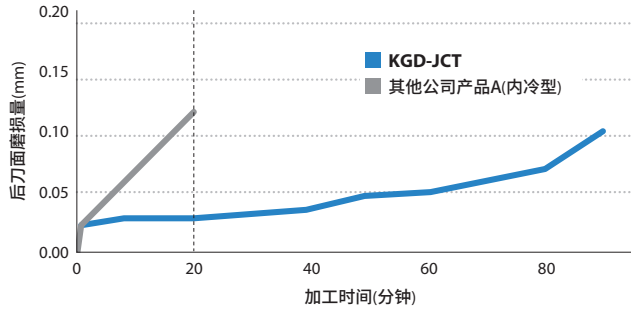

切削参数：Vc=80m/min, f=0.06mm/rev (~2mm: f=0.02mm/rev), KGD1625H-2JCT, GDM2020N-015PF PR1535(刃宽:2.0mm) 被削材：SUS304 (φ25) 内冷(1.5MPa)切边加工

冷却液喷射状态 (示意图)

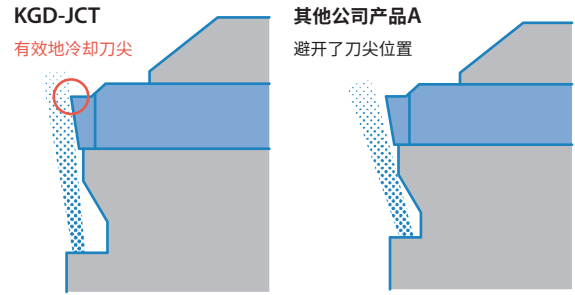

刀尖状态 (加工20分钟后)

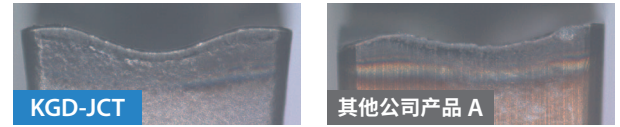

KGD-JCT 通过使用高密度·高速的内冷喷射, 有效地冷却刀尖, 实现优异的冷却效果从而延长寿命

自动车床用 KGD-JCT

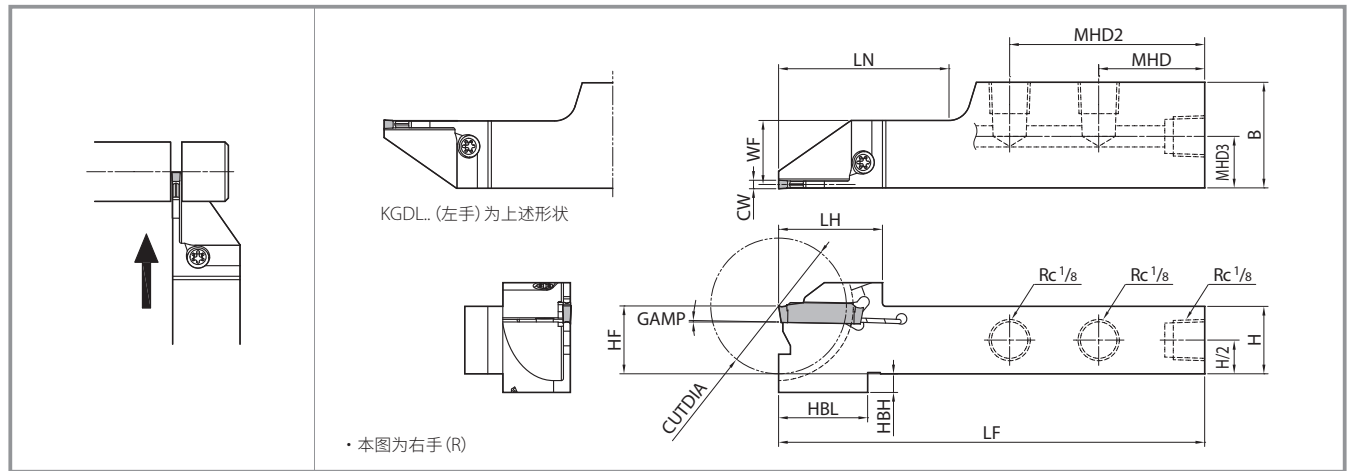

型号	库存	加工径	尺寸 (mm)										角度		刃宽 CW (mm)		适合刀片
			CUTDIA	H=HF	HBH	B	LF	LH	HBL	LN	WF	MHD	MHD2	MHD3	GAMP	MIN.	
KGDR 1220H-2JCT	●	24	12	8.5	20	100	19.5	21	44	11.2	35	-	8.4	1°	2.0	3.0	GDM型 GDG型 (GDMS型) (GDGS型)
KGDL 1220H-2JCT	●						21.5	7.7									
KGDR 1625H-2JCT	●	32	16	4.5	25	100	24.5	21	40	15.2	25	46	12.2	1°	2.4	3.0	
KGDL 1625H-2JCT	●						7.7										
KGDR 1220H-2.4JCT	●	24	12	8.5	20	100	19.5	21	44	11	35	-	8.4	1°	2.4	3.0	
KGDL 1220H-2.4JCT	●						21.5	7.7									
KGDR 1625H-2.4JCT	●	32	16	4.5	25	100	24.5	21	40	15	25	46	12.2	1°	3.0	4.0	
KGDL 1625H-2.4JCT	●						7.7										
KGDR 1220H-3JCT	●	24	12	8.5	20	100	19.5	21	44	10.8	35	-	8.6	1°	3.0	4.0	
KGDL 1220H-3JCT	●						21.5	7.7									
KGDR 1625H-3JCT	●	32	16	4.5	25	100	24.5	21	40	14.8	25	46	12.2	1°	3.0	4.0	
KGDL 1625H-3JCT	●						7.7										

● : 标准库存

零件	紧固螺钉		扳手		插销	
		SB-40120TR		LTW-15S		GP-1

适合刀片、切削参数以及配管零件等请参考「综合样本」或是「自动车床用JCT系列样本」

京瓷切削工具应用程序, 为客户生产效率提高做出贡献。



京瓷(中国)商贸有限公司

机械工具事业部
上海市静安区万荣路700号大宁中心广场A3幢140室(200072)
TEL:021-3660-7711 FAX:021-5638-6200
http://www.kyocera.com.cn/prdct/cuttingtool/index.html



扫一扫
京瓷切削工具
微信公众平台



搜索
京瓷切削工具
微信小程序

京瓷 切削工具 检索
在京瓷网站获取最新信息。

